



**SEEMAX**

Things we are doing, all for quality!

- 📍 :Building A&B, No. 13, Dongrui 3<sup>rd</sup> Rd, Zhongshan City, 528415, Guangdong Province, China
- ☎️ : +86-760-22124546 ext.812
- 📞 : +86-13416083266
- ✉️ : michael@seemaxfan.cn
- 🌐 : <https://seemaxfan.cn/>

# 2024 Catalog



# SEEMAX

## ABOUT US

Zhongshan SEEMAX Electrical Appliance Co.,Ltd, founded in 2014 and located in the well-known small household appliance industry zone, Zhongshan, Guangdong, pass ISO9001, BSCI audit every year, offering one-stop sourcing solution for HomeComfort Product: Electric Heater & Cooling Fan with CE, EMC, LVD, ERP, ROHS, CB, GS, ETL approval. SEEMAX owns a professional team integrated with R&D, Production, Quality Control & Sales Service with over 10-year exporting experience.

**18000** m<sup>2</sup>  
Factory area

**12** lines  
Production Lines

**1.2** million  
Annual Output / pcs

Own independent testing lab & a series of advanced testing equipments and modern motor production workshop.

Sell to about 40 countries and regions  
Over 100 cooperative partners



**40**  
countries



**100**  
partners

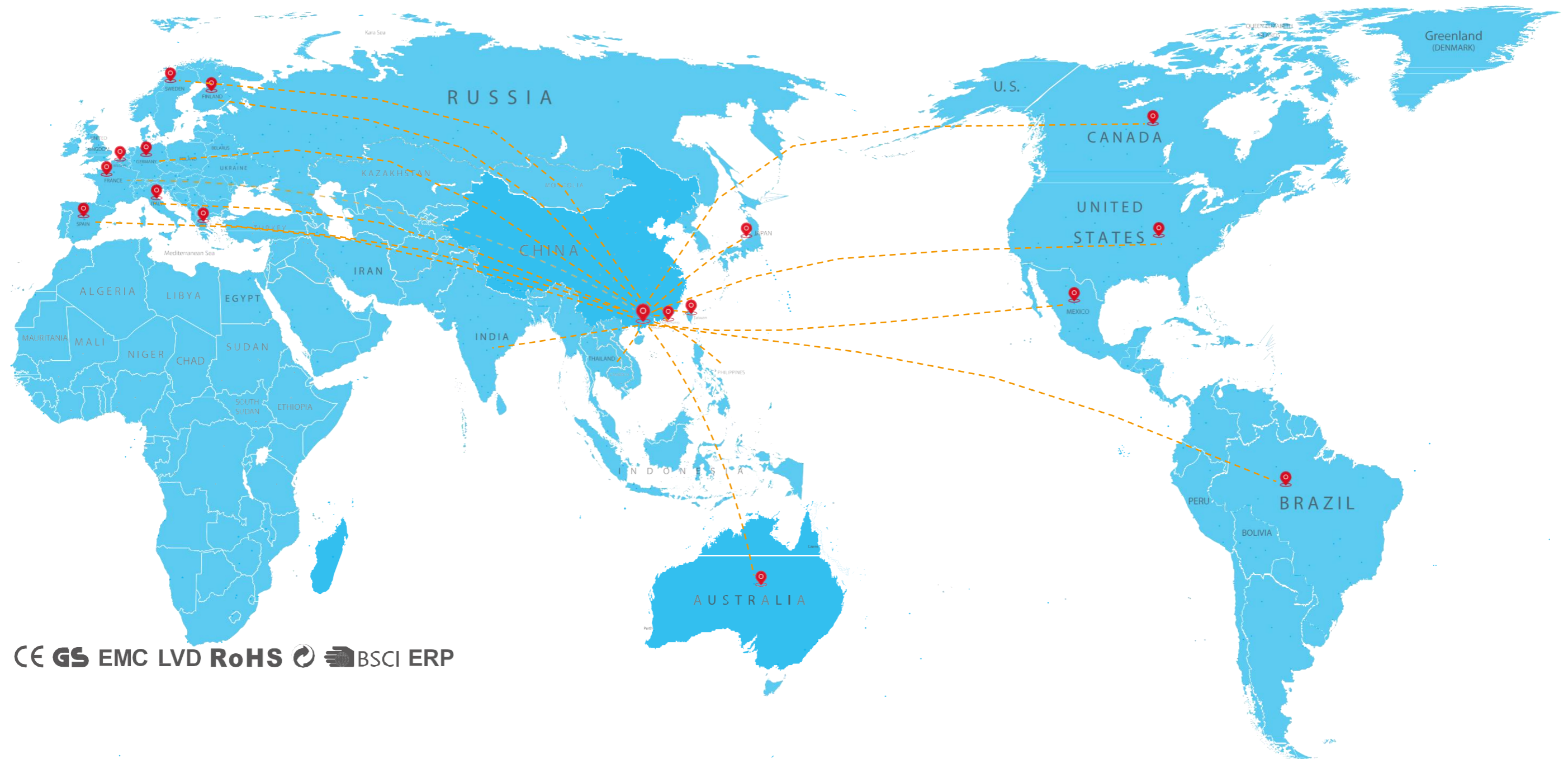

CE GS EMC LVD RoHS BSCI ERP



PRODUCTION



SHOW ROOM



MOTOR WORKSHOP



EXHIBITIONS

COOLING FAN

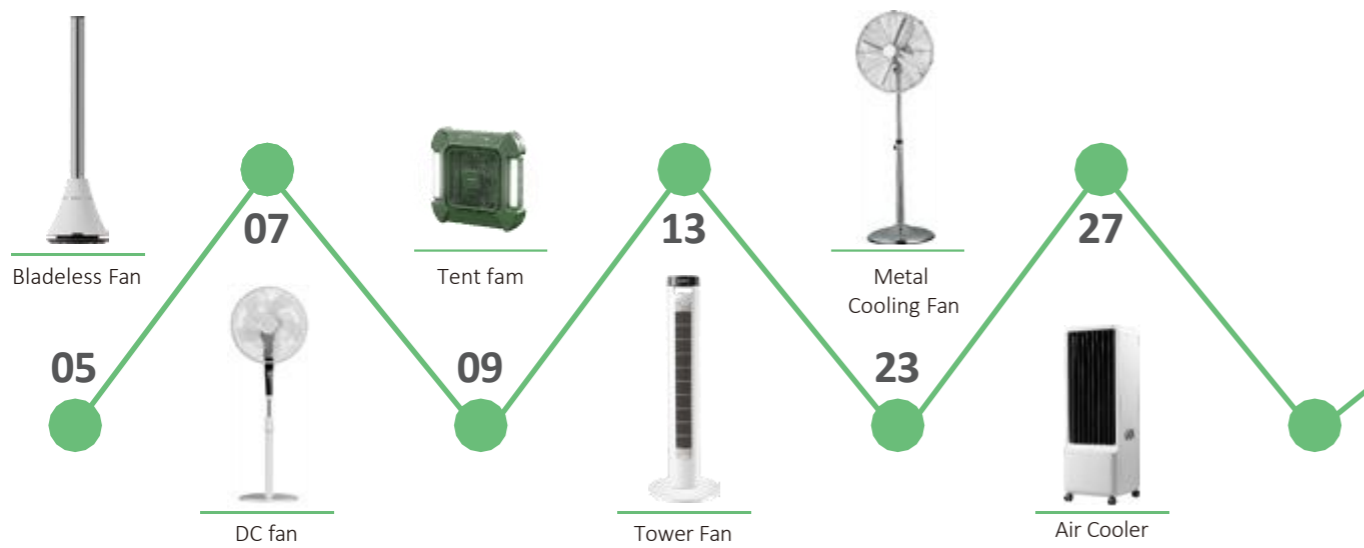

WARM HEATING

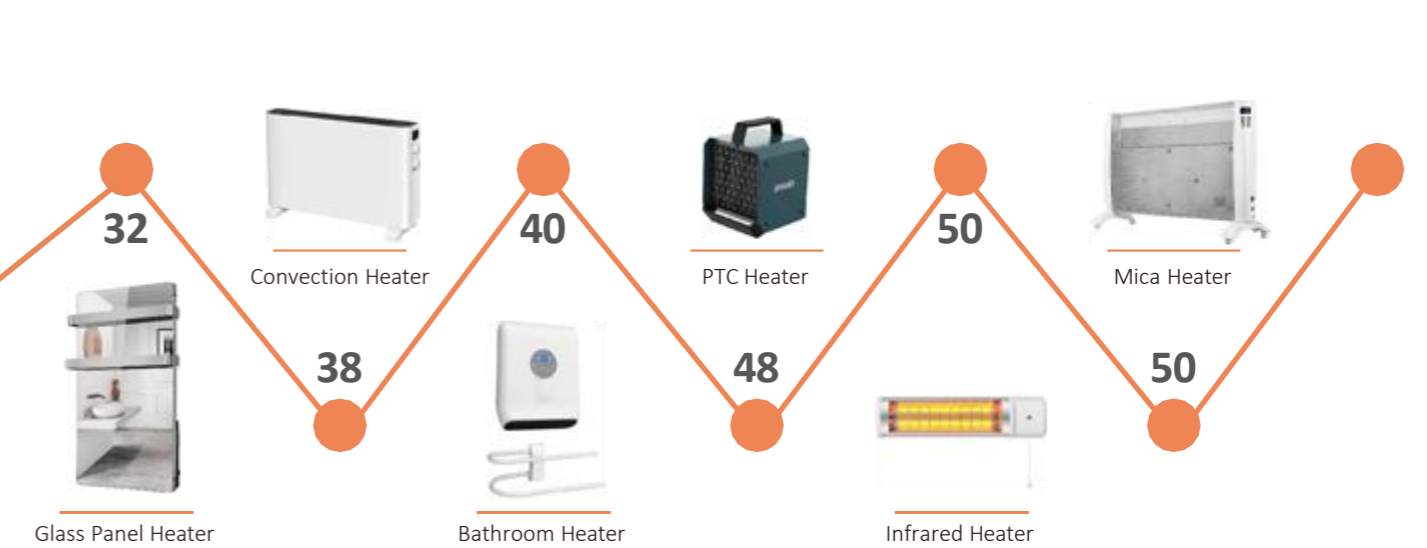

# BLADELESS FAN

Chic & Slim design  
Super quiet Strong wind

HEATING



## BLADELESS FAN-NEW ARRIVAL NBF-2103 / NBF-2103H / NBF-2103C / NBF-2103E

Chic & Slim design, Super quiet, Strong wind

- Power output: 30W
- 8 Speed Setting, fan speed up to 4.35m/s
- 7.5H Timer Setting
- 90° Oscillation
- LED display & indicator
- Touch sensitive buttons
- Remote control
- Power cord storage
- Quite operation: ≤51dB
- Optional color: White or Customized
- Product Size: 270x270x980mm
- N.W.: 2.4KGS

**Optional function:**

- Heating function: 1800W MAX (NBF-2103H)
- Detachable air outlet pipe (NBF-2103C)



Control panel



Decorative ring



Appearance color

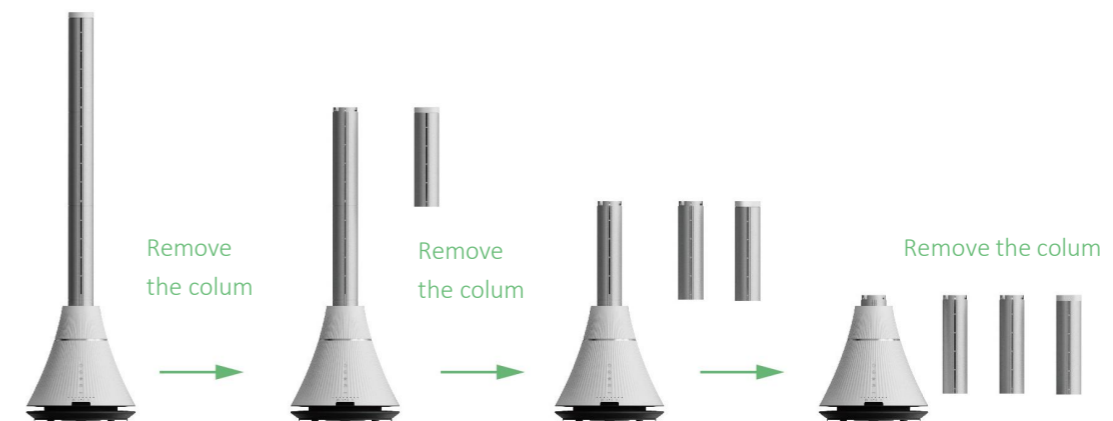

CE GS EMC LVD RoHS BSCI ERP



## DC TABLE FAN & DC STAND FAN

Slim ,  
space - saving design perfect for any room



### DC FLOOR & TABLE FAN FS -2302

Slim , space - saving design perfect for any room

- Easy to install easy to store and clean
- DC pure copper motor · Five fan blades
- Power output: 30W
- 7.5H Timer Setting
- 3 wind mode : sleep / nature / silent - auto oscillation
- 90° Oscillation
- LED display with room temperature touch buttons
- More sizes available : Table fan :12"/16"/18"
- Optional color : White , Black or Customized



### DC STAND FAN FS -2301

Slim , space - saving design perfect for any room

- Easy to install easy to store and clean
- DC pure copper motor · Five fan blades
- Power output: 30W
- 7.5H Timer Setting
- 3 wind mode : sleep / nature / silent - auto oscillation
- 90° Oscillation
- LED display with room temperature touch buttons
- More sizes available : Floor fan :16"/18"
- Optional color : White , Black or Customized



# TENT FAN-NEW ARRIVAL FS-2206

Suspendable,  
Reverse charging,Lighting



Appearance  
color(customizable)



# TENT FAN-NEW ARRIVAL FS-2206

Suspendable, Reverse charging, Lighting

- Power output: 15 W
- Super silence: maximum dB < 50db
- TENT FAN-NEW ARRIVALFS-2206
- Suspendable, Reverse charging Lighting
- 3 settings of fan speed: L-M-H
- 70° Auto Oscillation for cooling fan
- 7.5H timer
- 3 settings of the LED light, L-M-H
- 180° rotary of the LED light
- Rechargeable, USB type- Connector
- LED power indicator
- Can be desktop use or hanging use
- Can be used as power bank
- Optional color: Green, White sliver or customized
- Product dimension: 260x254x80mm
- N W.: 1KGS



support



buttons&indications



rotatable lighting



CE GS EMC LVD RoHS BSCI ERP



**MINI TOWER FAN  
TF-2202**

Slim , space-saving tower design , easy to move

- 33cm ( 13 " ) Mini Table Tower Fan
- Power output : 20W
- 3 speeds control
- Left-right 70° Oscillation
- Fan speed : 7m / second ( Max)
- Noise level < 55db ( A )
- Product Size : 113x113x335mm
- N.W. : 1 . 16KGS
- Optional color : White , Black or Customized



Control panel



Remote control store

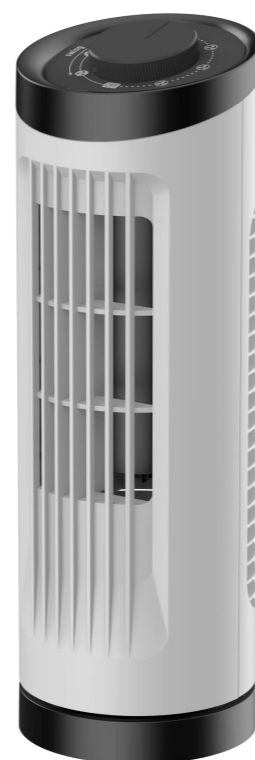

**MINI TOWER FAN  
TF-2007**

Slim , space-saving tower design , easy to move

- 33cm ( 13 " ) Mini Table Tower Fan
- Power output : 20W
- 3 speeds control
- Left-right 70° Oscillation
- Fan speed : 7m / second ( Max)
- Noise level < 55db ( A )
- Product Size : 113x113x327mm
- N.W. : 1 . 19KGS
- Optional color : White , Black or Customized



Control panel



Remote control store



**MINI TOWER FAN  
TF-2007-E**

Slim , space-saving tower design , easy to move

- 33cm ( 13 " ) Mini Table Tower Fan
- Power output : 20W
- 4H Timer
- LED indicator touch control button
- 3 speeds control
- Left-right 70° Oscillation
- Fan speed : 7m / second ( Max)
- Noise level < 55db ( A )
- Product Size : 113x113x327mm
- N.W. : 1 . 19KGS
- Optional color : White , Black or Customized



Control panel

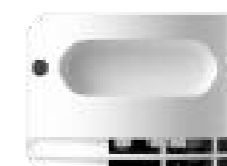

Remote control store



# TOWER FAN

Slim,  
space-saving design perfect for any room



## TOWER FAN-NEW ARRIVAL TF-2003-36 / TF-2003-46

Slim, space-saving design perfect for any room

- 94cm ( 36 ") Tower fan / 107cm ( 46 ") Tower fan
- Power output : 45W
- 3 wind modes : normal , natural , sleep
- Luxury LED display
- 2 color moods lighting ( Orange Blue lighting )
- 3 speed settings : low-medium-high
- 8H Timer
- Super quiet air delivery
- Left-right 90° Oscillation
- Remote control
- Product Size : 315x315x940mm / 315x315x1070mm
- N.W. : 3 . 49KGS / 4 . 49KGS
- Optional color : White/Black/Silver or Customized

### Optional function:

- WIFI
- onizer



Control panel



Remote control store



LED display



Base





# TOP-SELLING TOWER FAN

Slim,  
light weigh space-saving design perfect for any room



## TOP-SELLING TOWER FAN TF-2001

Slim,light weigh space-saving design perfect for any room

- 76cm ( 30" ) Tower Fan
- Power output: 45W
- 3 Variable Speed Settings
- Wind speed: 7m/s
- 120min Timer
- Overheat protective motor
- Left-Right 90° Oscillation
- Product Size: 240x240x770mm
- N.W.: 2.48KGS
- Optional color: White, Black or Customized



Control panel



Base



Control panel

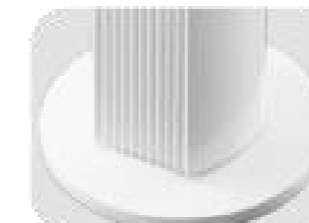

Base



## ELECTRONIC TOWER FAN SM-32EB

Used with air condition, energy saving

- 80cm ( 32" ) Tower Fan
- Power output: 45W
- 3 wind modes: normal, natural, sleep
- Luxury LED display and room temperature display
- 3 Variable speed settings
- 12H Timer
- Super quiet air delivery
- 70° Oscillation
- Remote control
- Product Size: 272x272x805mm
- N.W.: 2.6KGS
- Optional color: White, Black or Customized



Control panel



LED display



## ELECTRONIC TOWER FAN TF1005LR-E

Used with air condition, energy saving

- 90cm ( 36" ) Tower Fan
- Power output: 45W
- 3 wind modes: normal, natural, sleep
- Luxury LED display and room temperature display
- 3 Variable speed settings
- 12H Timer
- Super quiet air delivery
- 70° Oscillation
- Remote control
- Product Size: 315x315x955mm
- N.W.: 3.3KGS
- Optional color: White, Black or Customized



Control panel



LED display



### ELECTRONIC TOWER FAN SM-36EA

Used with air condition, energy saving

- 90cm ( 36 " ) Tower Fan
- Power output : 45W
- 3 wind modes :normal , natural , sleep
- Luxury LED display and room temperature display
- 3 Variable speed settings
- 12H Timer
- Super quiet air delivery
- 70°Oscillation
- Remote control
- Product Size : 280x280x920mm
- NW : 2 . 6KGS
- Optional color : White , Black or Customized



Control panel



Base



### MECHANICAL TOWER FAN SM-29K

Used with air condition, energy saving

- 72cm(29°) Tower Fan
- Power output: 45W
- 3 Variable speed settings
- 120min timer
- Super quiet air delivery
- 70° Oscillation
- Product Size: 220x220x745mm
- N.W.:2.1KGS
- Optional color: White, Black or Customized



Control panel



Base



### MECHANICAL TOWER FAN TF-75D

Used with air condition, energy saving

- 72cm ( 29 " ) Tower Fan
- Power output : 45W
- 3 Variable Speed settings
- 70° Oscillation
- 120 min timer
- Overheat protective motor
- Product Size : 275x275x730mm
- N.W. : 2 . 3KGS
- Optional color : White or Customized



Control panel



Base



### MECHANICAL TOWER FAN SM-30B

Used with air condition, energy saving

- Used with air condition , energy saving
- 80cm ( 32 " ) Tower Fan
- Power output : 45W
- 3 Variable Speed Settings
- 70° Oscillation
- 120 min timer
- Overheat protective motor
- Product Size : 260x260x805mm
- NW : 2 . 2KGS
- Optional color : White , silvery or Customized



Control panel



Base



# POWERFUL METAL FAN

Large shaking angle, Uniform air supply to every corner,  
Meet living needs



## POWERFUL METAL FAN FE-30 / FE-40 / FE-45 / FE-50

Large shaking angle, Uniform air supply to every corner,  
Meet living needs

- Powerful Floor Fan
- 3 speeds setting
- High velocity motor for maximum air circulation
- Precisely balanced blades make low noise
- Tilt adjustment for flexible use
- Optional color: Chrome, Copper or Customized

### Product data:

30cm(12"), 55W, 395x160x395MM, 2.8KGS  
40cm(16"), 100W, 500x195x480MM, 4.5KGS  
45cm(18"), 110W, 560x200x550MM, 5.4KGS  
50cm(20"), 125W, 595x200x580MM, 5.6KGS



Press button

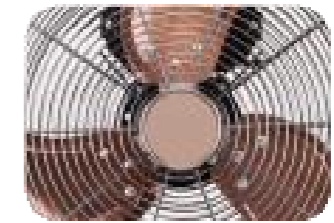

Different fan blade structures

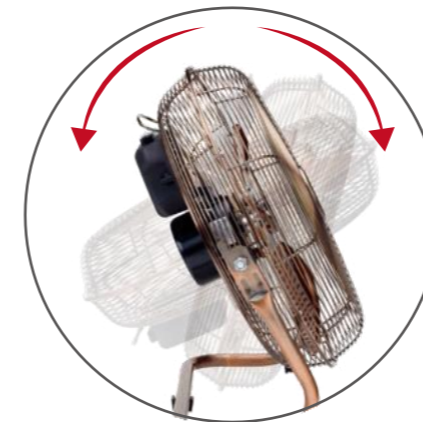
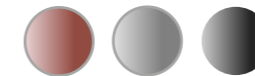

## METAL TABLE FAN

Large shaking angle, Uniform air supply to every corner,  
Meet living needs



## METAL TABLE FAN FT-30MC / FT-40MC

Large shaking angle, Uniform air supply to every corner,  
Meet living needs

- Metal Table Fan
- 3 speeds setting with 70° Oscillation
- 4 Metal blades
- Solid construction
- High performance and durability
- Tilt adjustment for flexible use
- Full power can run 300-400min
- Optional color: Chrome, Copper or Customized

- **Product data:**  
30cm(12"), 35W, 280x130x283MM, 2.6KGS  
40cm(16"), 50W, 450x300x450MM, 3.8KGS

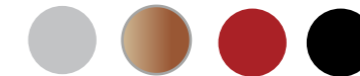

Spiral grill



Base



## METAL STAND FAN FD-40M

Large shaking angle, Uniform air supply to every corner,  
Meet living needs

- 40cm (16") Stand Fan
- Power output: 50W
- Solid construction
- 3 Variable speed settings
- Tilt adjustable head, 70° Oscillation
- Quiet operation
- Height adjustable, 125cm High
- Product Size: 450x390x125mm
- N.W.: 5.5KGS
- Optional color: Chrome, Copper, Black or Customized



Spiral grill



Base



# PLASTIC COOLING FAN

Large shaking angle,  
Uniform air supply to every corner, Meet living needs



## RECHARGEABLE FAN SM-R2

Small and exquisite, easy to carry



## PLASTIC TABEL FAN SDF-23J / 30J / 40J

Large shaking angle, Uniform air supply  
to every corner, Meet living needs



## RECHARGEABLE FAN SM-USB01

Small and exquisite, easy to carry



## PLASTIC STAND FAN SF-40J / YTSF40-22

Large shaking angle, Uniform air supply  
to every corner, Meet living needs



# AIR COOLER

Create coolness & restore the true natural wind



## AIR COOLER CF-2008

Create coolness & restore the true natural wind

- Power output: 80W
- LED display with room temperature
- Easy touch control panel with indicator
- 3 wind speeds: low-medium-high (9.4m/s)
- 4 wind modes selection: normal/nature/sleep/super
- Auto Oscillation: Up-Down, Left-Right
- 6L water tank, detachable for adding water & cleaning
- Water shortage indicator
- Remote control
- 12H Timer
- Caster wheels for easy moving around
- Ice box for extra cooling experience
- Product Size: 270x270x795mm
- N.W.: 6.8KGS
- Optional color: White, Black, Pink, Green or Customized

### Optional function:

- Wi-fi function
- Semi-conductor electric cooling technology
- Ionizer function
- HEPA 13 Filter
- PM2.5 detector
- Remote magnetic placement



Control panel



6L water tank



Remote control



WiFi function



Water temperature drops 10°C in 2 hours



Clean Air, Cooling Air  
True H13 HEPA



# GLASS PANEL HEATER

Full bath heating,  
waterproof and quick heating, towel drying.



## GLASS PANEL HEATER SPECIAL FOR BATHROOM-NEW ARRIVAL GH-2109

Full bath heating, waterproof and quick heating, towel drying.

- 2 heating power: 1000W/2000W
- Front tempered glass panel
- Sensitive touch panel & LED display
- IP24 Dustproof & Waterproof
- 3 modes settings (high/low/silent)
- 5-40°C temperature adjustment
- Week timer
- Window open detection
- With towel rack
- Special for bathroom wall-mounted use
- Product Size: 341x110x562mm
- NW: 4.23KGS
- Optional color: White, Mirror

• **Optional function:**

- Wifi function
- Body detector
- Ionizer function
- Remote control



2000W



TIMER



IP24



TOWEL RACK





## GLASS PANEL HEATER SPECIAL FOR BATHROOM GH-05

Full bath heating , waterproof and quick heating.

- 220-240V 50-60HZ 500W IPX4
- LED display & with soft touch-key control
- Week timer program
- PET heating element
- 5-35°C temperature adjustment
- Front Tempered Glass
- Wall mounted use
- Over-heating protection
- Intelligent open window detection
- Product Size : 450x30x1200 mm
- NW : 9 . 5KGS
- Optional color : White , Black

**Optional function:**

- Wifi function

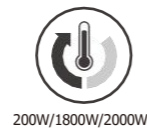

## GLASS PANEL HEATER SPECIAL FOR BATHROOM GH-20TURBO-W

Full bath heating , waterproof and quick heating.

- Heating setting: 2000W
- Working Mode: 200W heating film  
1800W PTC heating with turbo  
2000W full power heating
- IPX4 waterproof
- Front LED display & with soft touch-key control
- Week timer program
- 5-35°C temperature adjustment
- Intelligent open window detection
- Wall mounted special for bathroom use
- Dust filter
- Over-heating protection
- Towel rack (up and down slidable )
- Product Size: 470x170x820mm
- N.W.: 9.9KGS
- Mirror color: White, Black

**Optional function:**

- Wifi function
- Body detector

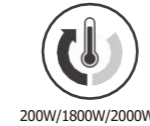

## GLASS PANEL HEATER SPECIAL FOR BATHROOM GH-20TURBO-M

Full bath heating , waterproof and quick heating.

- Heating setting: 2000W
- Working Mode: 200W heating film  
1800W PTC heating with turbo 2000W  
full power heating
- IPX4 waterproof
- Front LED display & with soft touch-key control
- Week timer program
- 5-35°C temperature adjustment
- Intelligent open window detection
- Wall mounted special for bathroom use
- Dust filter
- Over-heating protection
- Towel rack (up and down slidable )
- Product Size: 470x170x820mm
- N.W.: 9.9KGS
- Optional color: Full length mirror surface

**Optional function:**

- Wifi function

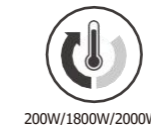

# GLASS PANEL HEATER

Intelligent constant temperature, comfortable and energy-saving.



## GLASS PANEL HEATER-ELECTRONIC TYPE GH-1901-15 / GH-1901-20

Intelligent constant temperature, comfortable and energy-saving.

- Tempered glass front panel
- IPX4 waterproof
- LED display & touch button
- Week timer
- 2 heating setting  
GH-1901-15:  
750W/1500W  
GH-1901-20:  
1000W/2000W
- Anti-frost function
- Remote control
- 5-35°C electronic thermostat
- Over heating protection
- Tip over protection
- Intelligent open window detection
- Free standing use or wall mounted use
- Carry handle
- Product Size: 630x230x480mm / 780x230x480mm
- N.W.: 5.9KGS / 7.7KGS
- Optional color: White, Black



750W/1500W



TIMER



IPX4



TIP-OVER SWITCH



CE GS EMC LVD RoHS BSCI ERP





### GLASS PANEL HEATER-NEW ARRIVAL GH-1601M / GH-1601M-7

Full bath heating , waterproof and quick heating,towel drying.

- 2 heating setting :  
GH-1601M: 750W/1500W  
GH-1601M-7: 500W/1000W
- Pilot lamp
- Over-heating protection
- Adjustable temperature control
- Front tempered glass
- Tip-over protection inside
- Free standing use
- Carry handle
- Turning knob on the side
- Product size:620x200x390mm/500x200x370mm
- NW.:4.4KGS/4.13KGS
- Optional color: White, Black



**Optional function:**

- Aluminum heating element
- IPX4 Waterproof

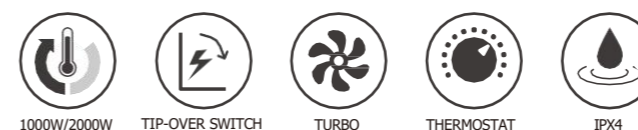

### GLASS PANEL HEATER-NEW ARRIVAL GH-1601M-20

Full bath heating , waterproof and quick heating,towel drying.

- Pilot lamp
- 2 heating setting: 1000W/2000W
- Over-heating protection
- Adjustable temperature control
- Front tempered glass
- Tip-over protection inside
- Free standing use
- Carry handle
- Optional color: White, Black,cyan



CE GS EMC LVD RoHS BSCI ERP



# CONVECTION HEATER

Surging warm current and Convective heating.



## CONVECTION HEATER

### CH-1802

Surging warm current and Convective heating.

- Screwless design
- 2 heating powers: 1000W/ 2000W
- Adjustable thermostat
- Overheat protection
- Tip over protection switch
- Class II
- Mobile standing use only
- Product Size: 627x190x405mm
- N.W.: 3.3KGS
- Optional color: White, Black or customized

**Optional function:**

- 2H or 24H timer

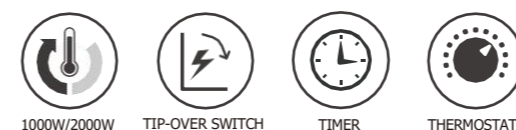

## CONVECTION HEATER

### CH-1802T

Surging warm current and Convective heating.

- Screwless design
- 2 heating powers: 1000W/ 2000W
- Adjustable thermostat
- Tip over protection switch
- Turbo fan
- Overheat protection
- Class II
- Mobile standing use only
- Product Size: 627x190x405mm
- N.W.: 3.94KGS
- Optional color: White, Black or customized

**Optional function:**

- 2H or 24H timer

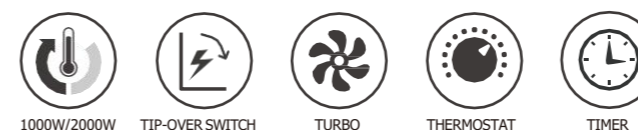

# CONVECTION HEATER

Surging warm current and Convective heating.



## CONVECTION HEATER

### TLS-601

Surging warm current and Convective heating.

- Screwless design
- 2 heating powers: 1000W/ 2000W
- Adjustable thermostat
- Overheat protection
- Tip over protection switch
- Class II
- Mobile standing use only
- Product Size: 680x165x420mm
- N.W.: 3.9KGS
- Optional color: White, Black or customized

**Optional function:**

- Turbo fan function
- 1H timer

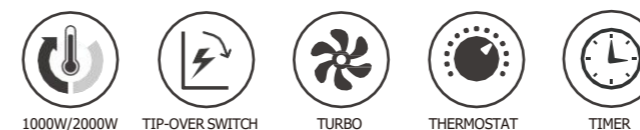

## CONVECTION HEATER

### TLS-603T

Surging warm current and Convective heating.

- Screwless design
- 2 heating powers: 1000W/ 2000W
- Adjustable thermostat
- Tip over protection switch
- Turbo fan
- Overheat protection
- Class II
- Mobile standing use only
- Product Size: 680x165x420mm
- N.W.: 4.0KGS
- Optional color: White, Black or customized

**Optional function:**

- 2H timer

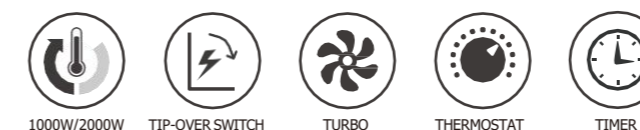



### BATHROOM HEATER BH-1401EU

IP24 waterproof and dustproof, safe to use.

- LED display with soft touch-key control
- Mode : 2000W/1000W/Towel heating bar
- Color kit interchangeable
- Week timer with wake-up function
- 5-40°C temperature adjustment
- Over-heating protection
- Body detector
- IP24 dustproof and waterproof
- Dust filter clean remind function
- Rotatable towel rack
- Wall mounted special for bathroom use
- Product Size : 385x170x605mm (open)  
385x173x405mm (folded)
- N.W. : 3 . 88KGS
- Optional color : White



CE GS EMC LVD RoHS BSCI ERP

### BATHROOM HEATER BH-1701T

IP24 waterproof and dustproof, safe to use.

- LED display & with soft touch-key control
- IP24 dustproof & waterproof
- Color kit interchangeable
- Week timer with wake-up function
- Mode: 2000W/1000W/Fan
- 5-40°C temperature adjustment
- Wall mounted special for bathroom use
- Over-heating protection
- Dust filter clean remind function
- Product Size: 310x130x380mm
- N.W.: 3.1KGS
- Optional color: White



### BATHROOM HEATER BH-1701E

IP24 waterproof and dustproof, safe to use.

- LED display & with soft touch-key control
- IP24 dustproof & waterproof
- Color kit interchangeable
- Week timer with wake-up function
- Mode: 2000W/1000W/Fan
- 5-40°C temperature adjustment
- Wall mounted special for bathroom use
- Over-heating protection
- Body detector
- Dust filter clean remind function
- Rotatable towel rack with heating
- Product Size: 355X145X580(open)  
355X153X380(folded)
- N.W.: 3.27KGS
- Optional color: White



CE GS EMC LVD RoHS BSCI ERP

## BATHROOM HEATER BH-1400TE

IP24 waterproof and dustproof, safe to use.

- LED display & with soft touch-key control
- IP24 dustproof & waterproof
- Week timer
- Mode: 2000W/1000W/Fan
- 5-35°C temperature adjustment
- Wall mounted special for bathroom use
- Over-heating protection
- Automatic electronic thermostat
- Intelligent open window detection
- Product Size: 300x120x385mm
- N.W.: 2.0KGS
- Optional color: White



## BATHROOM HEATER BH-1401TE

IP24 waterproof and dustproof, safe to use.

- LED display & with soft touch-key control
- IP24 dustproof & waterproof
- Week timer with wake-up function
- Mode: 2000W/1000W/Fan
- 5-35°C temperature adjustment
- Wall mounted special for bathroom use
- Over-heating protection
- Fixed towel rack
- Product Size: 400x160x585mm
- N.W.: 2.5KGS
- Optional color: White

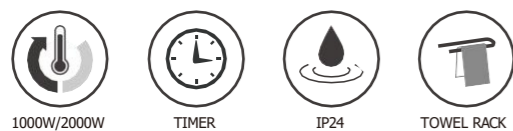

## BATHROOM HEATER BH-1402TE

IP24 waterproof and dustproof, safe to use.

- LED display & with soft touch-key control
- IP24 dustproof & waterproof
- Week timer
- Mode: 2000W/1000W/Fan
- 5-35°C temperature adjustment
- Wall mounted special for bathroom use
- Over-heating protection
- Automatic electronic thermostat
- Intelligent open window detection
- Rotatable towel rack
- Product Size: 340x120x550mm
- N.W.: 2.5KGS
- Optional color: White



# PTC HEATER

Small figure, warm the whole winter.



## NEW ARRIVAL-PTC HEATER PH-2206

Small figure, warm the whole winter.

- Cross-flow aluminum fan blades
- 3 working modes : 1200W/2000W/Fan
- LED display with touch panel OR Remote control
- 5-35°C temperature setting
- 8H timer
- 70° Auto Oscillation
- Anti-frost protection
- Air inlet filter
- 30s delay in the disconnection
- Over heat protection
- Tip-over protection
- Carry handle
- Optional color : White
- Product dimension : 170x170x315mm / 230x230x630mm



750W/1500W



TIP-OVER SWITCH



CE GS EMC LVD RoHS BSCI ERP



## PTC HEATER SM-05PTC

Small figure, warm the whole winter.

- Power setting: 500W
- Pilot lamp
- ON/OFF turning knob
- Adjustable thermostat
- Class V0 fire-resistant materials
- Over-heating protection
- Customized housing color
- Product Size: 110x105x200mm
- N.W.: 0.59KGS
- Optional color: White or customized

### Optional function:

- Wooden or chrome color for feet
- Dust filter
- Tip-over protection switch



## NEW ARRIVAL-PTC HEATER PH-2108

Small figure, warm the whole winter.

- Power Output: 2000W
- Independent ON/OFF switch & Control Knob
- Adjustable thermostat
- With over-heat protection
- IP21 Dustproof & Waterproof
- Carry handle & supporting feet
- Product Size: 165x140x177mm
- N.W.: 1.1KGS
- Optional color: White or customized

### Optional function:

- Tip-over protection switch



## PTC HEATER PH-1903-15

Small figure, warm the whole winter.

- 2 heat settings: 750W/1500W
- Vertical and horizontal use
- Top LED display & touch buttons
- 8H Timer
- Dual DC fan design, more powerful, noise < 45dB
- Independent On/Off switch, more safe
- 15-35°C adjustment temperature
- Over heating protection
- Safety tip-over switch built in
- Class V0 fire-resistant materials
- Suitable room area 15sqm
- Product Size: 120x120x300mm
- N.W.: 1.16KGS
- Optional color: White or customized





## CONVECTION HEATER

### INFRARED HEATER RH-1904-12

Simple design, make the whole winter warm people's heart.

- 2 power setting: 600W/1200W
- IPX4 waterproof
- 2 heating tubes
- Drawing Switch
- Up and down angle adjustable
- Aluminum housing
- Product Size: 547X132X95mm
- N.W.: 0.98KGS
- Optional color: White



500W/1000W



IPX4

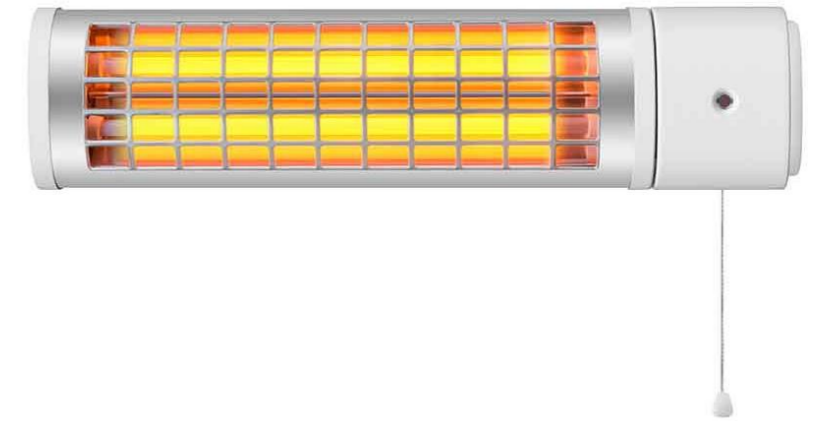

## MICA HEATER

### MICA HEATER MH-1905-15

Intelligent constant temperature, comfortable and energy-saving.

- 2 heating mode: 750W/1500W
- IP24 dustproof & waterproof
- LED display and press button
- Week timer with wake up function
- 5-40°C temperature adjustment
- Electronic thermostat
- Over heating protection
- Tip over safety switch
- Window open detection
- Free standing use with carry handle and Caster feet
- Wall mounted use
- Product Size: 745x265x555mm
- N.W.: 4.4KGS
- Optional color: White, Black



750W/1500W



TIMER



IP24



TIP-OVER SWITCH



CE GS EMC LVD RoHS BSCI ERP

# 2024 NEW-DESIGN

Products to be developed

**BLADELESS FAN  
NBF-2104**



**BLADELESS FAN  
NBF-2102**



**AIR COOLER  
CF-2102**



**MICA HEATER  
MH-1803**



**MICA HEATER  
MH-1804**



**GLASS PANEL HEATER  
CH-2302**



**DC FLOOR FAN  
FS-2204**



**METAL STAND FAN  
FD-40M-W**



**PTC HEATER  
PH-1806**



**GLASS PANEL HEATER  
GH-1601E-20**



**CONVECTION HEATER  
CH-1805**



**BATHROOM HEATER  
BH-1809**



**PTC HEATER  
PH-1807**



**PTC HEATER  
PH-1808**



**PTC HEATER  
PH-2107**



**BATHROOM HEATER  
BH-1810**



**BATHROOM HEATER  
BH-1811**



# 2024 NEW-DESIGN

Products to be developed

PTC HEATER  
PH-1904



PTC HEATER  
PH-1905



PTC HEATER  
PH-1906



PTC HEATER  
PH-2113



PTC HEATER  
PH-2207



PTC HEATER  
PH-2208



PTC HEATER  
PH-1907



PTC HEATER  
PH-1908



PTC HEATER  
PH-1909



PTC HEATER  
PH-2209



TOWER FAN  
TF-1910



TOWER FAN  
TF-1911



PTC HEATER  
PH-2110



PTC HEATER  
PH-2111



PTC HEATER  
PH-2112



TOWER FAN  
TF-1912



TOWER FAN  
TF-1913



# 2024 NEW-DESIGN

Products to be developed

**PTC HEATER  
PH-2203**



**PTC HEATER  
PH-2204**



**TOWER FAN  
TF-2009**



**TOWER FAN  
TF-2010**



**PTC HEATER  
PH-2205**



**PTC HEATER  
PH-2206**



**TOWER FAN  
TF-2011**



**TOWER FAN  
TF-2012**



# AC/DC FAN MOTOR

110-240V  
50/60Hz  
900-3200rpm/m

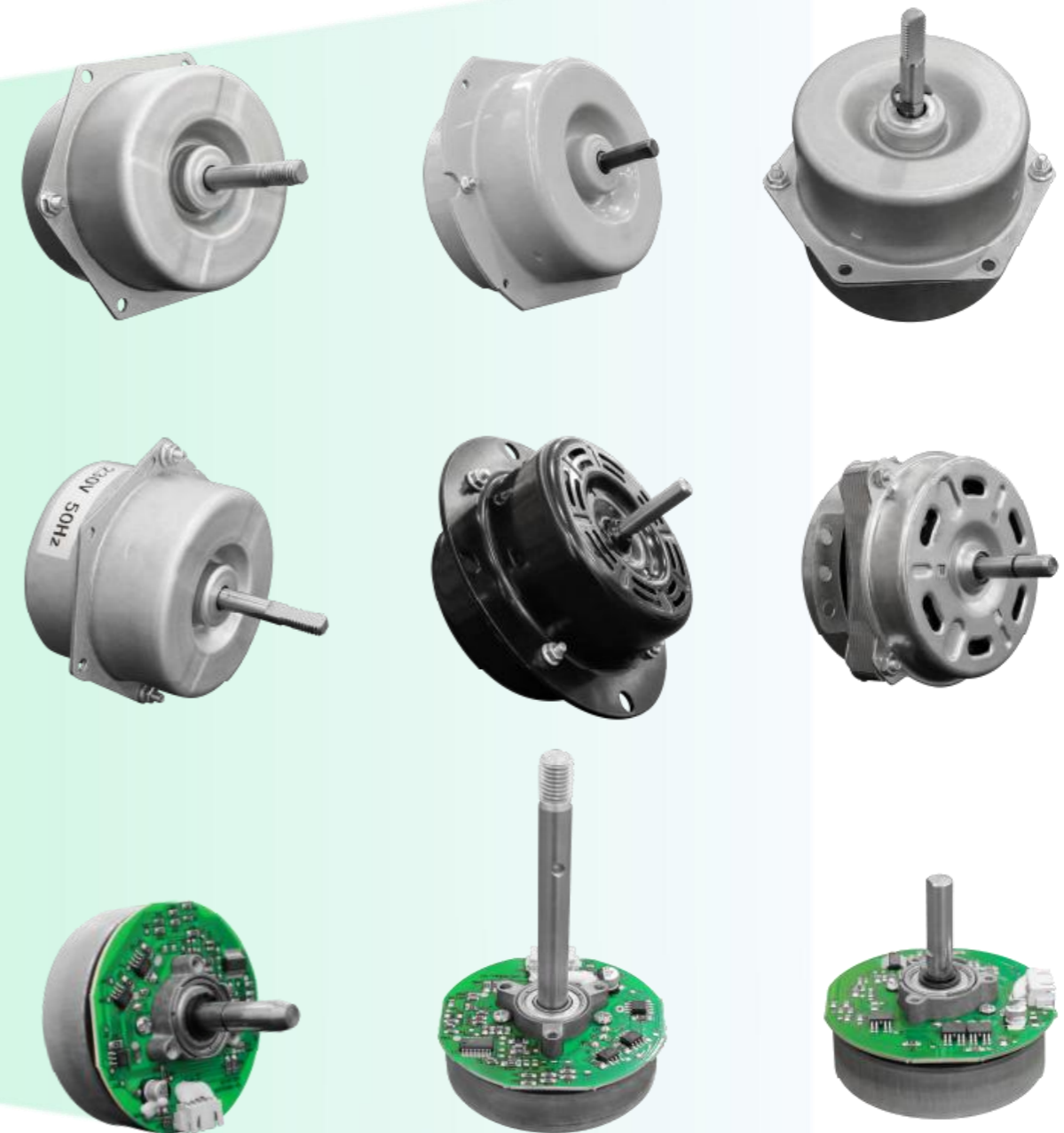

CE GS EMC LVD RoHS BSCI ERP



## AC/DC COOLER MOTOR

110-240V  
50/60Hz  
900-3200rpm/m

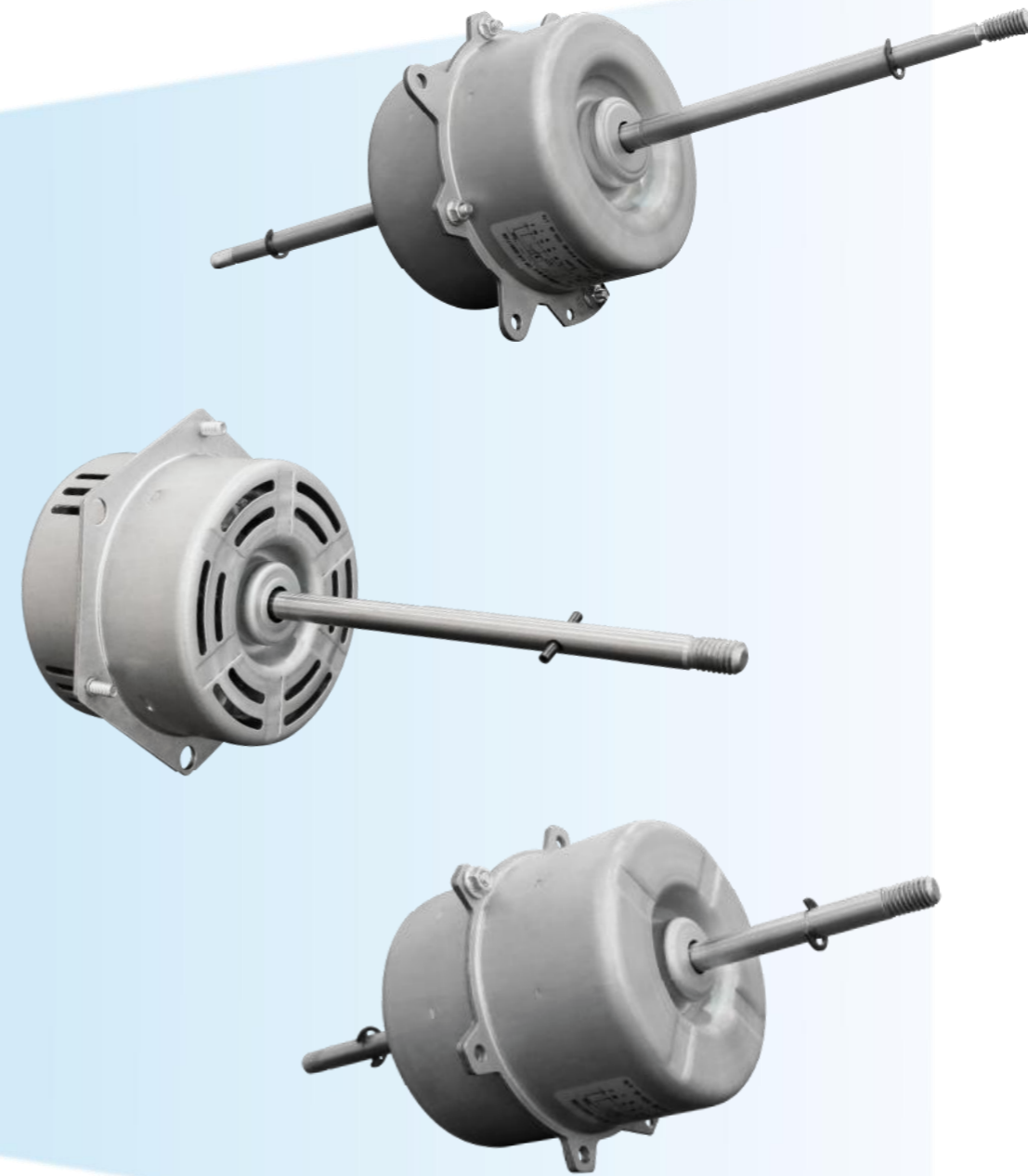

CE GS EMC LVD RoHS BSCI ERP

# AC/DC HEATER MOTOR



110-240V  
50/60Hz  
900-3200rpm/m

